

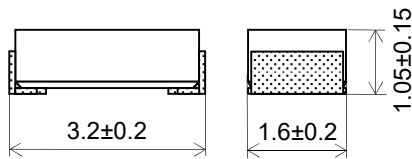

Dimensions and construction:



(mm)

Cover:	Ceramic
Case:	Ceramic
Terminal surface plating:	Tin plated, 2 µm or more
Terminal primary plating:	Nickel plated copper, 0.5 µm or more
Terminal substrate metal:	Copper t 0.1 mm
Adhesive:	Epoxy resin
Marking:	SOC 32V F [rated current]

Electrical characteristics:

Rated voltage	Certi- fication	Rated current (I _N)	Rated breaking current		Temperature rise	Current carrying capacity / Endurance test	Overload operation
AC 32 V DC 32 V	Ⓢ	800 mA 2.5 A 3.15 A 4 A 5 A	50 A	Resistive circuit	*1	*2	Within 2 min at 2.0 I _N 0.001 s–0.01 s at 10 I _N
DC 32 V	UL				75 K or less at 1.0 I _N	Until temperature stabilization occurs at 1.0 I _N	Within 60 s at 2.0 I _N

*1 70 K or less when measured during the final 5 min of the endurance test at 1.25 I_N.

*2 After repeating 100 cycles of 1.05 I_N for 1 h and switching off for 15 min, 1.25 I_N can be passed through the fuse for 1 h or more.

Typical cold resistance:

Rated current	Cold resistance
800 mA	130 mΩ
2.5 A	23 mΩ
3.15 A	20 mΩ
4 A	12 mΩ
5 A	9 mΩ

Note: These values are for reference only and are not intended to infer any guaranteed values.

Agency approval information:

Agency/Standard	Ratings covered
UL248-1, UL248-14 Recognized	800 mA, 2.5 A 3.15 A, 4 A, 5 A
SEMKO Certified EN (IEC) 60127-1, EN (IEC) 60127-4 Standard sheet 2	

Pre-arcing I-t characteristic:

These I-t curve plots are of the average values of the measurements obtained under the conditions specified by our company. These data are for reference only and are not intended to infer any guaranteed values. Characteristics of the fuse may vary depending on the usage conditions. Always test the fuse under the actual circuit conditions.

Control No.: 051202

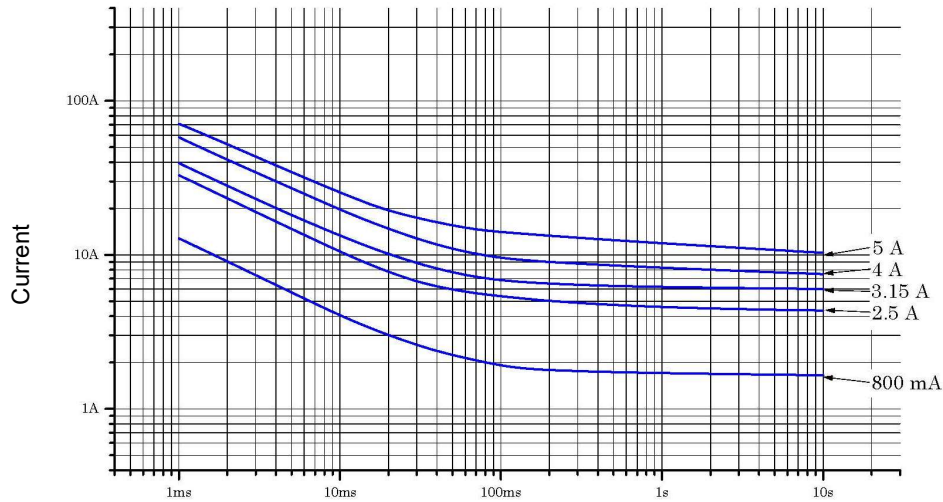

Pre-arcing time

Pre-arcing I²t characteristic:

These I²t curve plots are of the average values of the measurements obtained under the conditions specified by our company. These data are for reference only and are not intended to infer any guaranteed values. Characteristics of the fuse may vary depending on the usage conditions. Always test the fuse under the actual circuit conditions.

Control No.: 051202

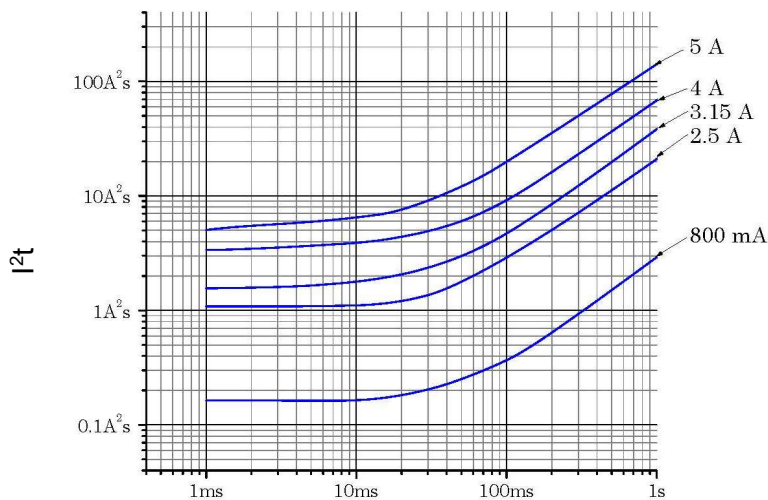

Time

Influence of ambient temperature—the re-rating of the rated current:

This chart is a plot of the measurements obtained at the ambient temperatures of -20 °C, 25 °C, and 85 °C under conditions specified by our company. The conditions of your actual application are not considered in this chart. These data are for reference purposes only and are not intended to infer any guaranteed values. Fuse characteristics may vary depending on the usage conditions. Always test the fuse under the actual circuit conditions.

Control No.: 160407

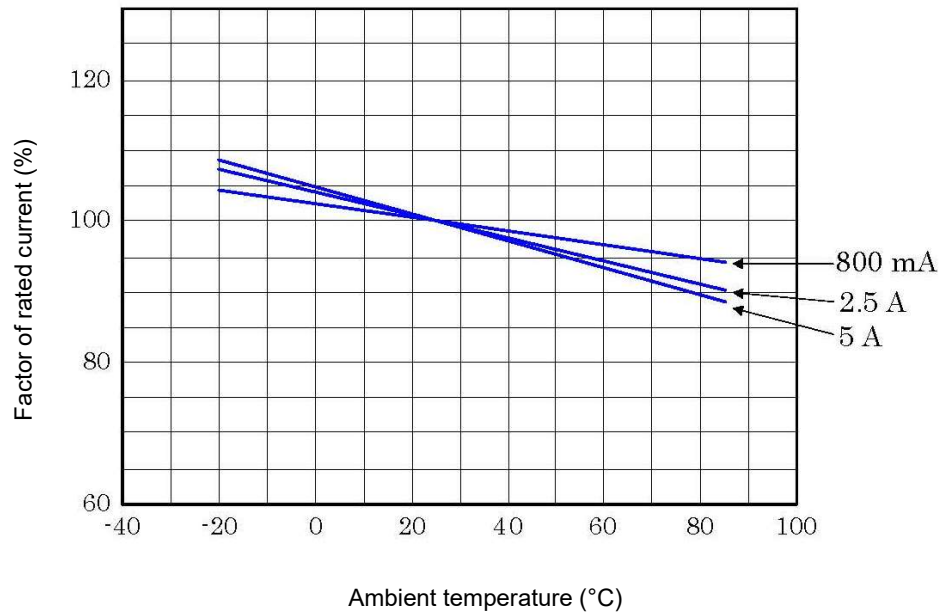

Mounting:

Reflow soldering:

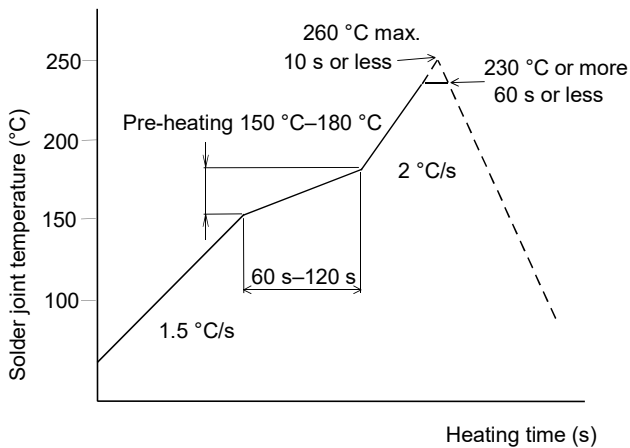

Soldering can be repeated two times under the conditions above.

Hand soldering with soldering iron:

Temperature: 380 °C or less
 Duration: 5 s or less
 Board: Glass fabric base epoxy resin
 t=1.6 mm
 Solder: Sn-3.0Ag-0.5Cu

Land pattern:

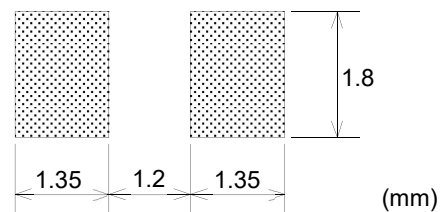

Note: Thickness of the solder paste applied to the board shall be 0.15 mm or less.

⚠ Land pattern and soldering conditions described above are examples when facilities in our company are used. Please make sufficient evaluations under the actual conditions in your company because the conditions may vary depending on facilities, solder type, solder quantity, board size, and board material.

⚠ Do not touch the terminal directly with a soldering iron. Do not apply any stress on the fuse body when the body and/or terminal are/is heated.

Lot number:

The lot number indicates the following:

Example: 16012371 160123: Date manufactured
 71: Process code

Usage conditions:

- * Ambient temperature: -20 °C–+85 °C
- * Ambient humidity: 85% RH or less

Note: Current carrying capacity of the fuse may vary depending on the ambient temperature.

Storage conditions and storage period:

Products packaged as delivered can be stored for one year from our shipment under the following conditions.

- * Ambient temperature: -20 °C–+40 °C (no condensation)
- * Ambient humidity: 85% RH or less
- * Ambient atmosphere: Not exposed to corrosive gas or sea breeze
No visible dust
Not exposed to direct sunlight
- * Load: No application of load that may cause deformation or degradation of the product.

Environmental information:

This product conforms to the EU RoHS Directive 2011/65/EU. The six hazardous substances (lead, mercury, cadmium, hexavalent chromium, polybrominated biphenyls [PBB], and polybrominated diphenyl ethers [PBDE]) specified in the EU RoHS Directive are not used intentionally in this product. However, when lead is used in applications exempted from the requirements of the Directive, this will be indicated in the Dimensions and Construction section of the corresponding product specification.

Packaging:

- Packaging code: R08B4 Products packaged on tape
 B Products packaged in a plastic bag
- Carrier tape : Type II-Blister carrier tape with single sprocket holes (the width of the tape is 8 mm) stipulated in JIS C 0806-3 Packaging of Components for Automatic Handling Part 3: Packaging of Surface Mount Components on Continuous Tapes (see Figure 1).
- Reel: JEITA ET-7200C Reusable Reel for Packaging of Components for Automatic Handling The reel also mostly complies with JIS C 0806-3 Packaging of Components for Automatic Handling-Part 3: Packaging of Surface Mount Components on Continuous Tapes (see Figure 2).
- Package quantity: R08B4 2,000 pcs.
 B 100 pcs.
- Contents of marking The following information shall be indicated on one side of the reel.
- Your part number (by request)
 - Lot no.
 - Quantity of fuses
 - Packaged date
 - Packaging code
 - Country of origin
 - Manufacturer
 - Production facilities
 - Indications specified by the applicable standards

Figure 1

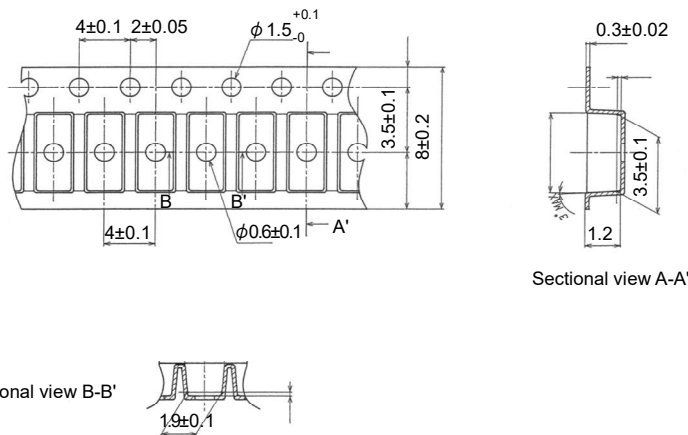
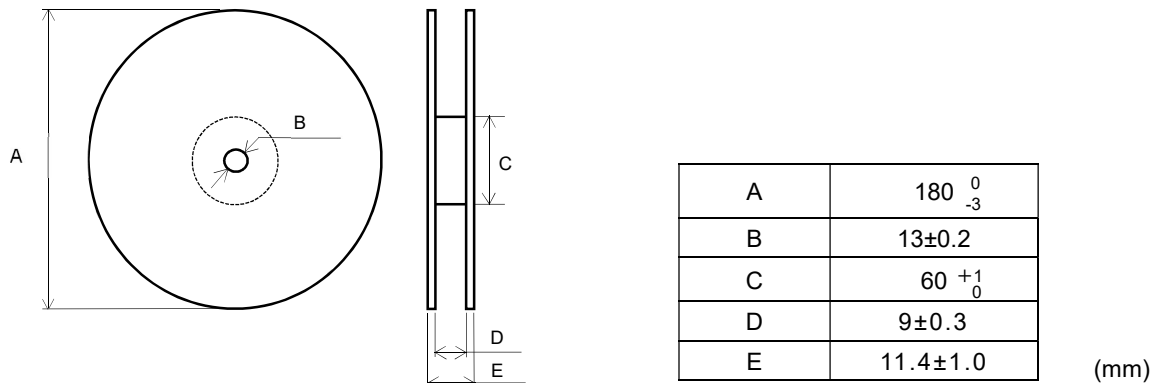

Figure 2



Ordering specifications:

SOC product name: 32V11CF [rated current] [packaging code]

Contact information:

SOC is a global ISO-9001 and TS16949 registered company headquartered in Japan with subsidiaries in Asia, Europe, and North America.

SOC Corporation
Marketing Division: 3-16-17, Takanawa, Minato-ku, Tokyo 108-0074, Japan
TEL +81-3-5420-1011 FAX +81-3-5420-6699
<http://www.socfuse.com/contact/index.html>

SOC America Inc.: 3505 Veterans Memorial Highway, Suite K-1, Ronkonkoma, NY 11779, USA
TEL +1-631-472-6666 FAX +1-631-472-6777
info@socamericainc.com <http://www.socamericainc.com>

SOC Asia Pte. Ltd.: 15 Jalan Kilang Barat, #06-02 Frontech Centre, Singapore 159357
TEL +65-6376-4115 FAX +65-6376-4117
socjp@pacific.net.sg

SOC Europe B.V.: Databankweg 1, 3821 AL Amersfoort, The Netherlands
TEL +31-33-450-4000 FAX +31-33-450-4009
info@soceurope.nl <http://www.soceurope.nl>

Safety Precautions for Fuse Selection and Use: **WARNING**

Read and follow these precautions before selecting and using fuses and protectors (hereafter “fuses”). Failure to properly select, install, and use fuses can result in not only property damage, but also serious injury or death.

Use fuses within their specification requirements. Exposing fuses to conditions that exceed or are outside specifications can lead to, for example, non-operation, nuisance operations, disconnection of the fuse-element, or explosions, and may cause injuries and/or property damage.

Fuse performance can vary greatly due to the actual conditions fuses are operated under (ambient temperature, pulse currents, heat shock, mechanical stress, etc.). Please consider all conditions a fuse will be exposed to when making a selection. Depending on the conditions, non-operation, nuisance operations, disconnection of the fuse-element, explosions, or other accidents may occur, and these may cause injuries and/or property damage.

The breaking ability of a fuse will differ between AC and DC circuits. Use fuses with AC voltage ratings in AC circuits and fuses with DC voltage ratings in DC circuits. When using fuses with both AC and DC voltage ratings, attention should be given to any differences in breaking ability. A fuse’s breaking ability indicates the fuse’s ability in an AC or DC circuit. For example, if a fuse with an AC voltage rating is used in a DC circuit, the fuse’s breaking ability will decrease, and injuries and/or property damage may occur.

Check if the circuit voltage is large enough for the fuse’s operation. When the circuit voltage is too small, the decrease in current caused by an increase in the fuse’s resistance may prevent the fuse from operating even for abnormal currents.

Do not use fuses in environments with high humidity or corrosive or flammable gases. Doing so may result in nuisance operations, disconnection of the fuse-element, or an explosion.

Do not use ultrasonic waves to clean fuses. Ultrasonic cleaning may cause disconnection of the fuse-element.

Do not form a fuse’s leads when the fuse is at a temperature of 40 °C or greater. Doing so may result in disconnection of the fuse-element because of the applied stress.

Do not apply coating or potting to any fuses except sealed fuses, such as the MCFA, or their equivalents, including the MCF3. Doing so may cause disconnection of the fuse-element or a change in the fuse’s characteristics. Please be aware that even sealed fuses or the equivalent are not hermetically sealed, and therefore make sure to confirm no coating or potting material has penetrated the interior or any other location of the fuse before use. As coating or potting a fuse will change its characteristics, make sure to confirm that a coated or potted fuse still satisfies all requirements under actual usage conditions.

Avoid applying excessive force when inserting a fuse into a fuse holder. Doing so may result in the fuse cracking or in contact failure, and this may significantly reduce its ability to work properly or may shorten its life.

When a fuse is used in equipment that directly affects human life or that requires a high degree of reliability, more closely examine and evaluate the fuse in actual circuit conditions than is necessary for use in other general electronic equipment.

Do not touch fuses when they are carrying a current. Doing so may result in electrocution or serious burns.

Fuses obtained as samples should only be used for evaluation. Do not reuse fuses, but instead properly dispose of them.

For final fuse selection, make sure to install the fuse in the actual application in order to confirm the selected fuse satisfies all requirements.