

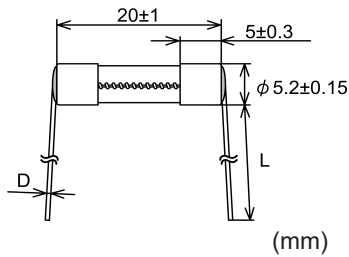

Dimensions and construction:



Tube: Lead-free glass  
 End-cap: Nickel plated brass  
 Lead wire: Tin plated copper  
 Solder: Sn-0.7Cu  
 Adhesive: Epoxy resin  
 Marking: 100 mA-less than 1 A  
 1 A-10 A

SOC [rated current] 250V  
 SOC [rated current] 250V

Rated current	D	L
100 mA-less than 5 A:	φ 0.5	30±5
5 A-10 A:	φ 0.8	40±5

Electrical characteristics:

Rated voltage	Certification	Rated current (I <sub>N</sub> )	Rated breaking current		Temperature rise	Current carrying capacity	Overload operation
			100 A	PF 0.7-0.8			
AC 250 V	*1	100 mA-10 A	100 A	PF 0.7-0.8	*2	Until constant temperature is obtained on each part at 1.1 I <sub>N</sub>	Within 60 min at 1.35 I <sub>N</sub> Within 2 min at 2.0 I <sub>N</sub>

\*1 Fuses with rated currents below 1 A are not covered under the Electrical Appliance and Material Safety Law.

\*2 140 K or less at the center of the insulating tube and 60 K or less at the contact while the fuse is carrying 1.1 I<sub>N</sub>.

Typical cold resistance:

Rated current	Cold resistance	Rated current	Cold resistance	Rated current	Cold resistance
100 mA	18 Ω	500 mA	650 mΩ	2.5 A	51 mΩ
125 mA	6.3 Ω	630 mA	475 mΩ	3.15 A	36 mΩ
160 mA	5.1 Ω	800 mA	275 mΩ	4 A	26 mΩ
200 mA	5.0 Ω	1 A	190 mΩ	5 A	20 mΩ
250 mA	3.9 Ω	1.25 A	145 mΩ	6.3 A	15 mΩ
315 mA	2.3 Ω	1.6 A	90 mΩ	8 A	11 mΩ
400 mA	865 mΩ	2 A	66 mΩ	10 A	7.1 mΩ

Note: These values are for reference only and are not intended to infer any guaranteed values.

Agency approval information:

Agency/Standard	Ratings covered
Conformity Certificate Specified in Clause 9 of the Electrical Appliance and Material Safety Law (EAMSL) of Japan has been issued by JET (Japan Electrical Safety & Environment Technology Laboratories)	1 A-10 A

Pre-arcing I-t characteristic:

These I-t curve plots are of the average values of the measurements obtained under the conditions specified by our company. These data are for reference only and are not intended to infer any guaranteed values. Characteristics of the fuse may vary depending on the usage conditions. Always test the fuse under the actual circuit conditions.

Control No.: 120710

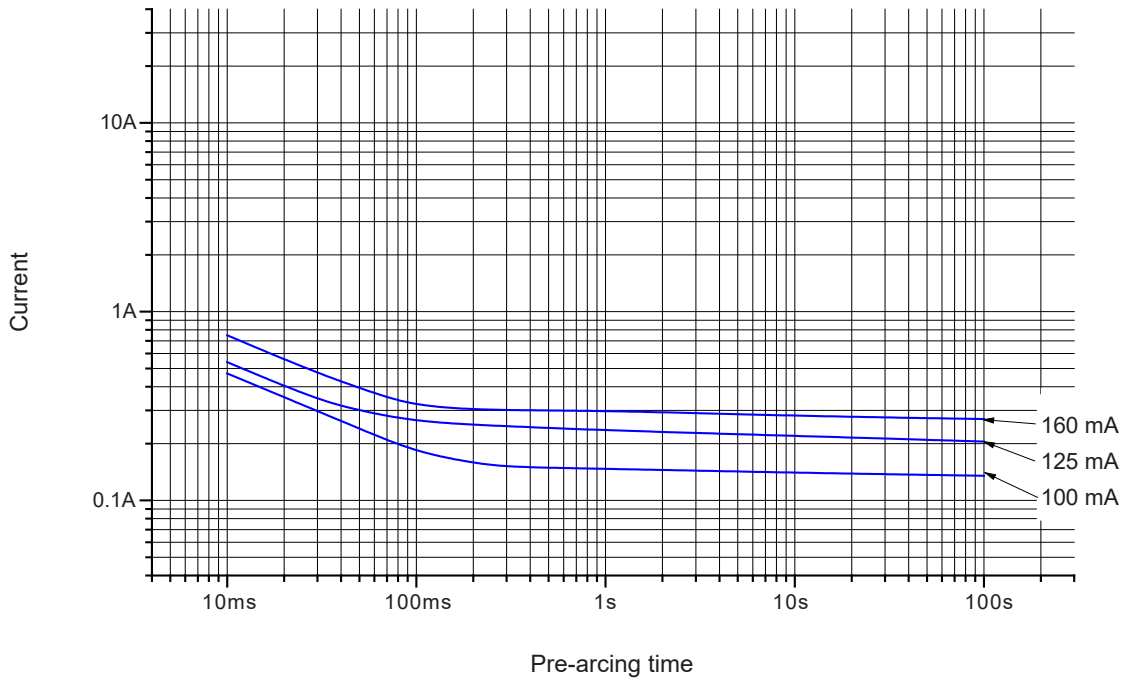

Control No.: 050401

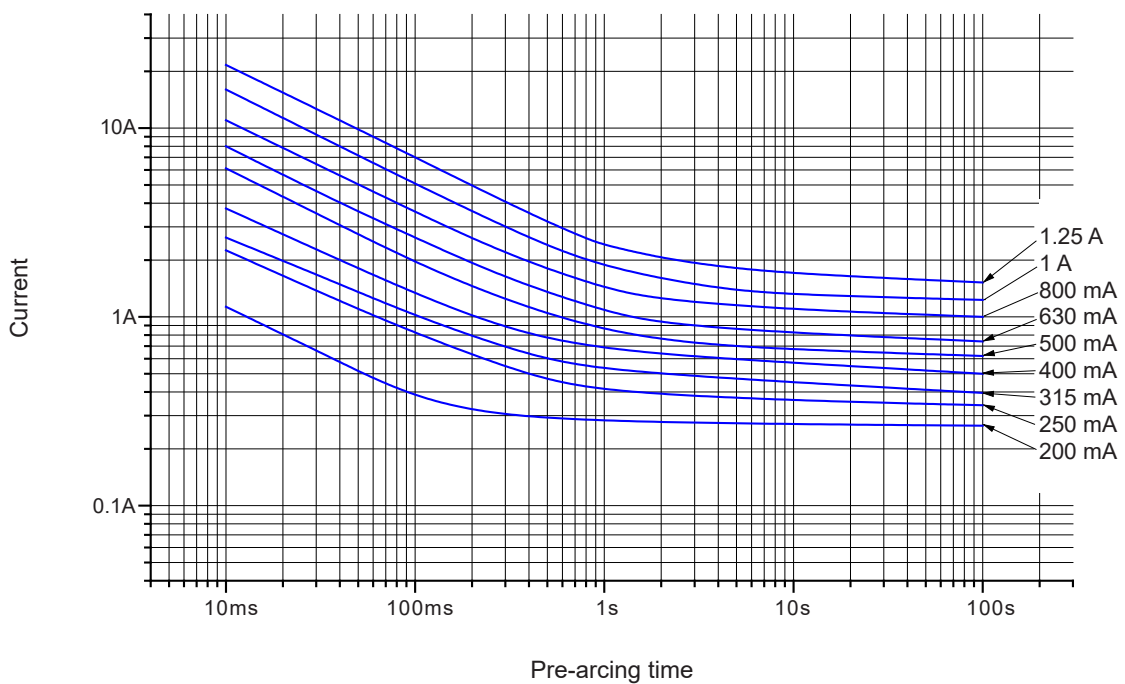

Pre-arcing I-t characteristic:

These I-t curve plots are of the average values of the measurements obtained under the conditions specified by our company. These data are for reference only and are not intended to infer any guaranteed values. Characteristics of the fuse may vary depending on the usage conditions. Always test the fuse under the actual circuit conditions.

Control No.: 050401

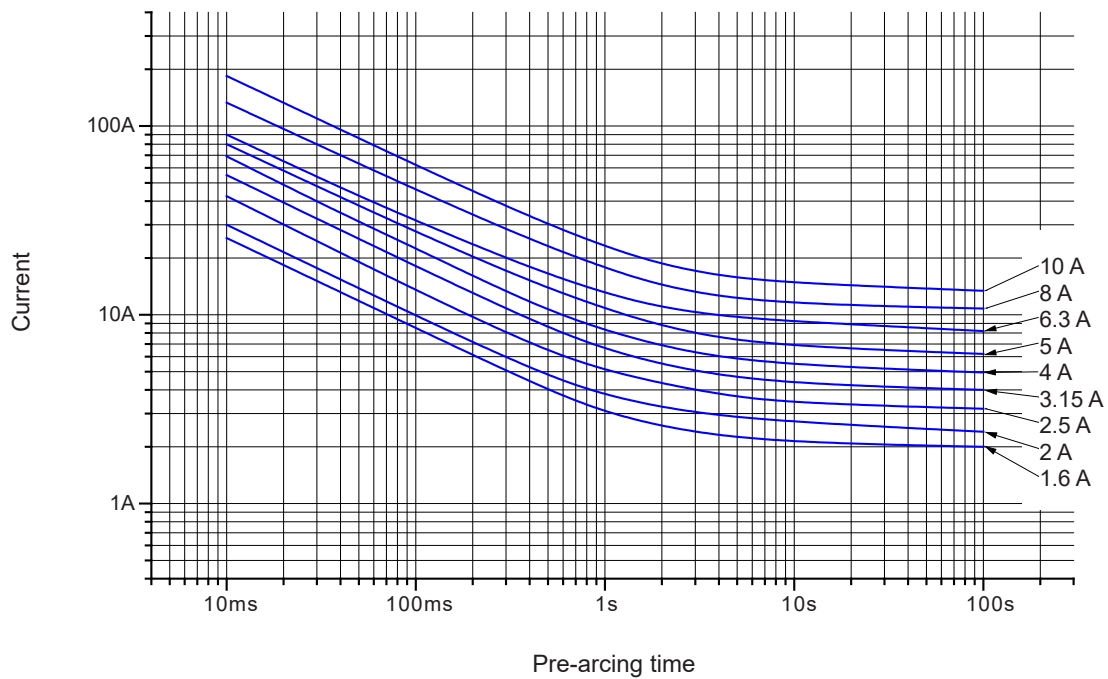

Pre-arcing  $I^2t$ -t characteristic:

These  $I^2t$ -t curve plots are of the average values of the measurements obtained under the conditions specified by our company. These data are for reference only and are not intended to infer any guaranteed values. Characteristics of the fuse may vary depending on the usage conditions. Always test the fuse under the actual circuit conditions.

Control No.: 060228

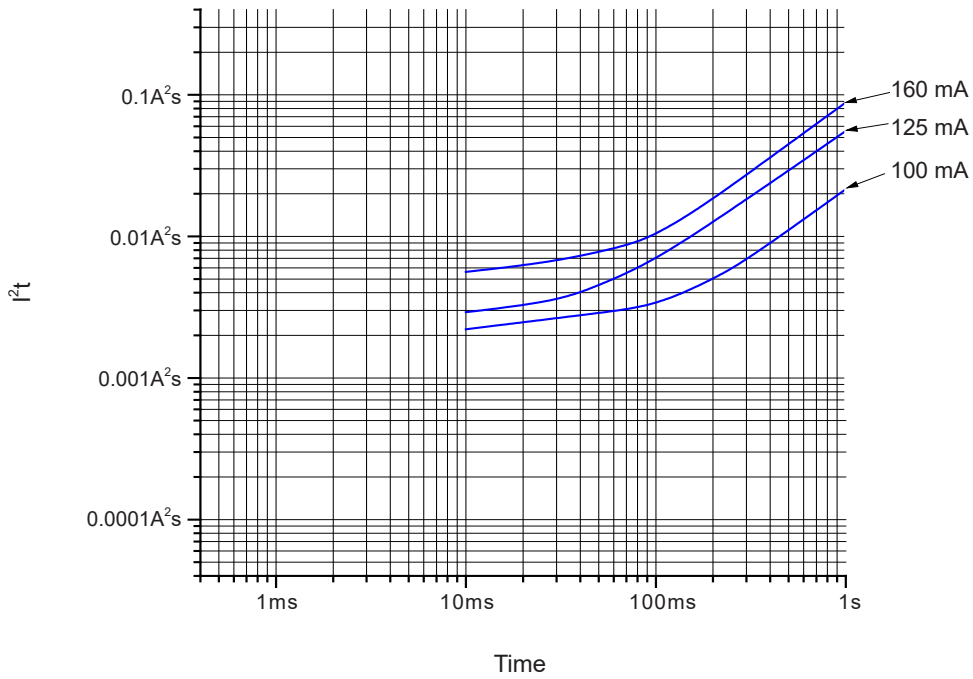

Control No.: 050401

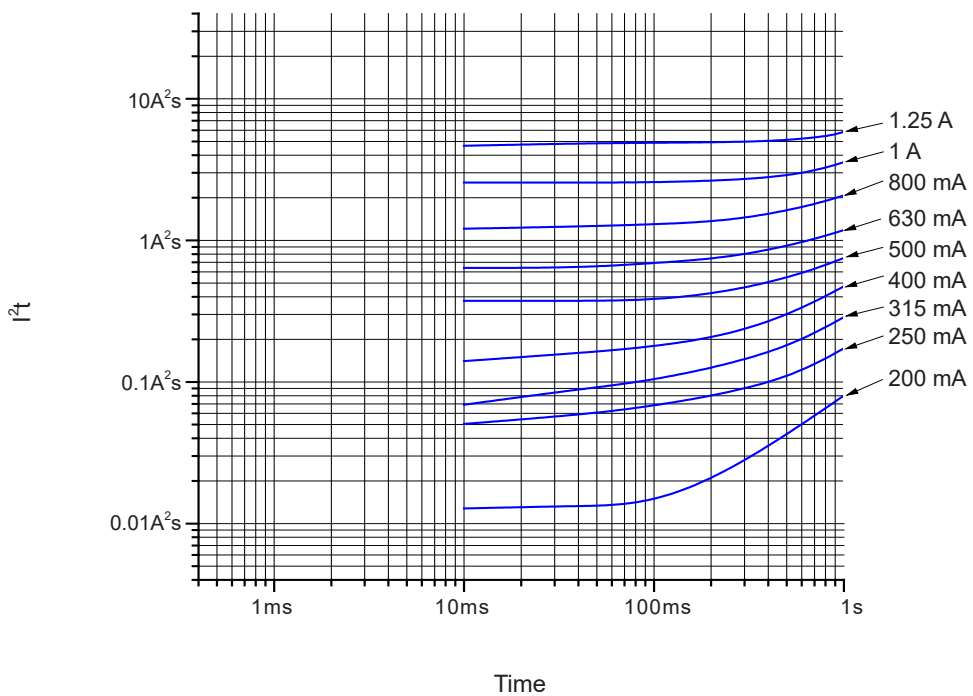

Pre-arcing  $I^2t$ -t characteristic:

These  $I^2t$ -t curve plots are of the average values of the measurements obtained under the conditions specified by our company. These data are for reference only and are not intended to infer any guaranteed values. Characteristics of the fuse may vary depending on the usage conditions. Always test the fuse under the actual circuit conditions.

Control No.: 050401

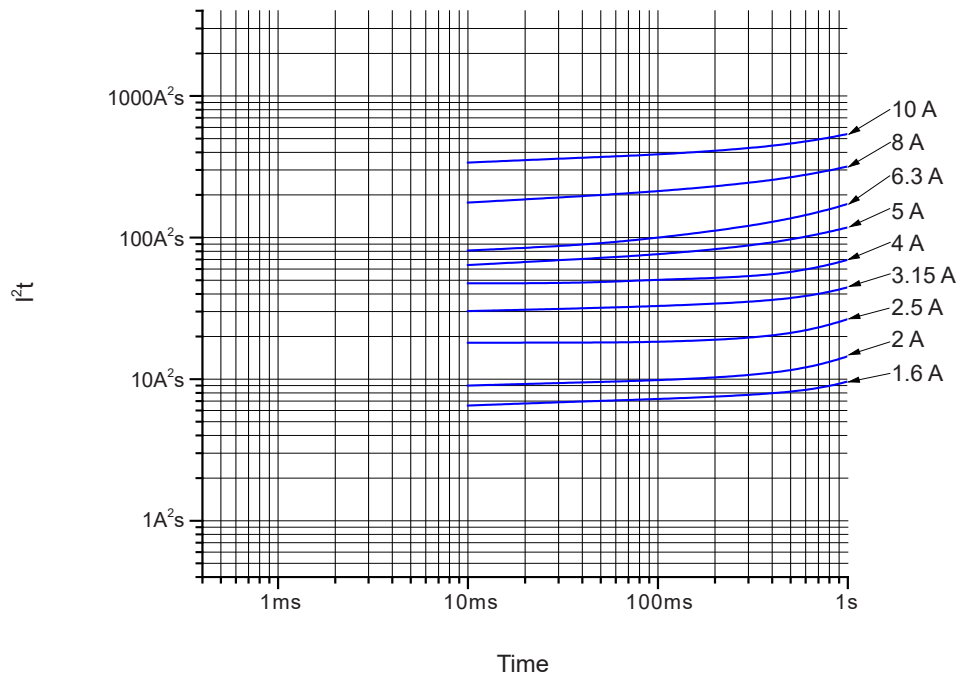

Influence of ambient temperature-the re-rating of the rated current:

This chart is a plot of the measurements obtained at the ambient temperatures of -40 °C, 25 °C, and 85 °C under conditions specified by our company. The conditions of your actual application are not considered in this chart. These data are for reference purposes only and are not intended to infer any guaranteed values. Fuse characteristics may vary depending on the usage conditions. Always test the fuse under the actual circuit conditions.

Control No.: 170401

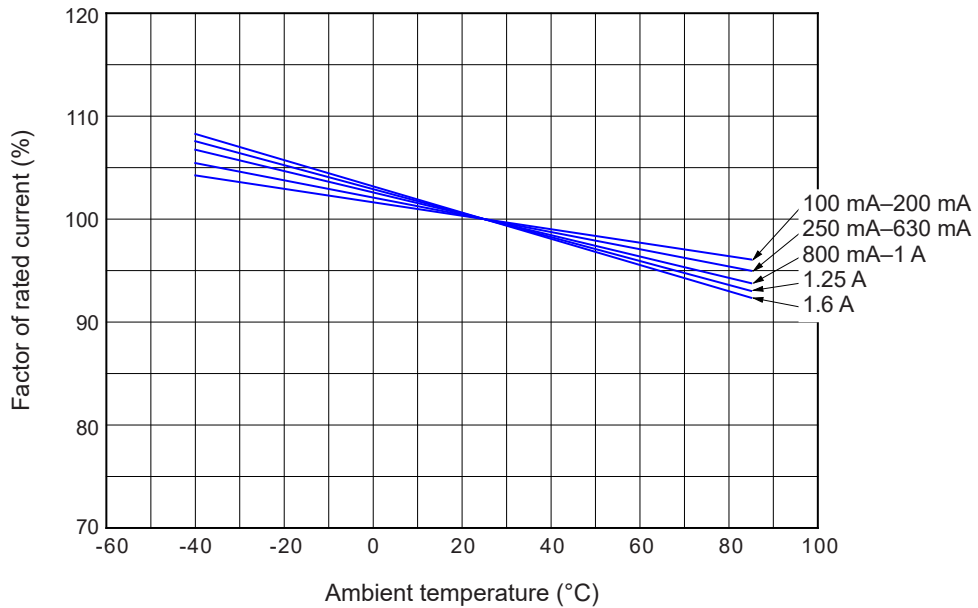

Control No.: 170401

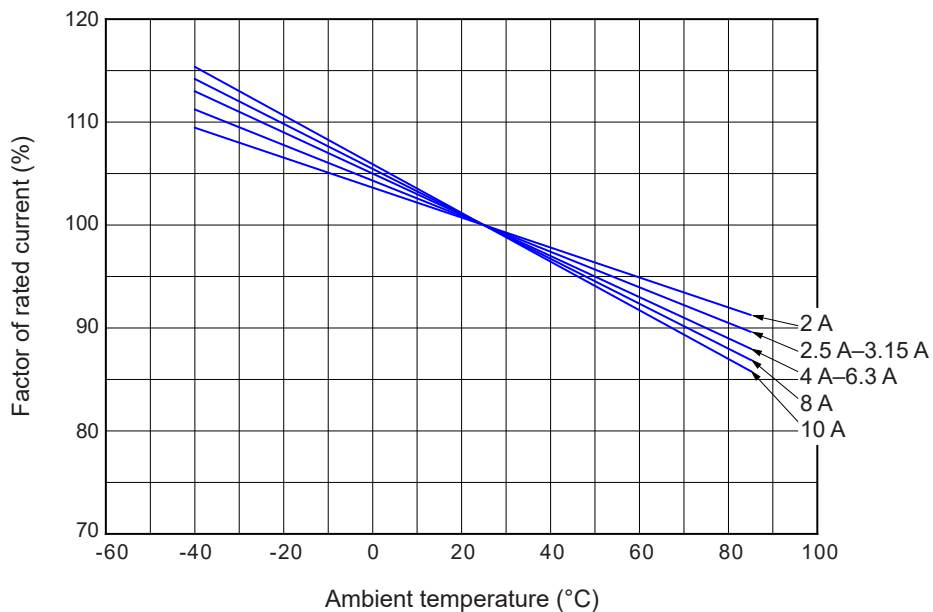

## Mounting:

### Wave soldering:

The soldering conditions stated below may be influenced by the material/shape and dimensions of the board, size of the copper foil, and/or heat capacity of the respective components on the board, besides such factors as temperature/duration of preheating, material of solder, temperature of the solder bath, and/or the duration of dipping.

- \* Length of the lead between the fuse body and the soldered surface of the board:
  - For  $\phi$  0.5 mm leads: L = 5 mm or more
  - For  $\phi$  0.8 mm leads: L = 8 mm or more
- \* Pre-heating: 80 °C–140 °C, 30 s–60 s
- \* Temperature of molten solder: 260 °C or less
- \* Duration: 7 s or less

### Hand soldering with soldering iron:

Depending on the components to which the fuse is attached (e.g., copper foil on the board) and/or heat capacity of the soldering iron tip, the soldering conditions may vary from those specified below.

- \* Length of the lead between the fuse body and the soldered surface of the board: L = 5 mm or more
- \* Soldering iron tip temp.: 380 °C
- \* Duration: 3 s or less

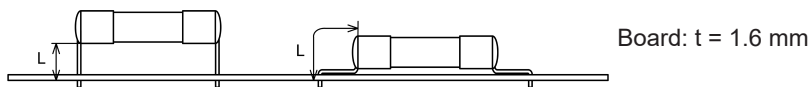

- \* Care must be taken not to apply any stress such as bending, twisting, rotating, or tension to the lead wire and the end-cap during heating of the fuse body by soldering and while it is kept at a high temperature of 40 °C or more.
- \* Do not apply any stress to the lead wire while the fuse body is being held, otherwise it may cause degradation of the end-cap portion. The part of the lead wire closest to the fuse should be held firmly when the wire is formed.



Specifications described above are examples when facilities in our company are used. Please make sufficient evaluations under the actual conditions in your company because the conditions may vary depending on facilities, solder type, solder quantity, board size, and board material.

**Usage conditions:**

- \* Ambient temperature:  $-40\text{ }^{\circ}\text{C}$ – $+85\text{ }^{\circ}\text{C}$
- \* Ambient humidity: 85% RH or less

Note: Current carrying capacity of the fuse may vary depending on the ambient temperature.

**Storage conditions and storage period:**

Products packaged as delivered can be stored for one year from our shipment under the following conditions.

- \* Ambient temperature:  $-30\text{ }^{\circ}\text{C}$ – $+40\text{ }^{\circ}\text{C}$  (no condensation)
- \* Ambient humidity: 85% RH or less
- \* Ambient atmosphere: Not exposed to corrosive gas or sea breeze  
No visible dust  
Not exposed to direct sunlight
- \* Load: No application of load that may cause deformation or degradation of the product.

**Environmental information:**

This product conforms to the EU RoHS Directive 2011/65/EU. The six hazardous substances (lead, mercury, cadmium, hexavalent chromium, polybrominated biphenyls [PBB], and polybrominated diphenyl ethers [PBDE]) specified in the EU RoHS Directive are not used intentionally in this product. However, when lead is used in applications exempted from the requirements of the Directive, this will be indicated in the Dimensions and Construction section of the corresponding product specification.

**Packaging:**

1. 100 fuses are packed into a colorless transparent polyethylene bag.
2. An identification label is attached to each bag.
3. The following number of bags containing 100 fuses each shall be packed into the cardboard case shown below.

For  $\phi$  0.5 mm leads: 4 bags

For  $\phi$  0.8 mm leads: 2 bags

If the number of fuses is less than the fixed number, the fuses are still packed into the cardboard case in the same manner.

4. The following are indicated on the surface of the cardboard case:

- \* Your part number (by request)
- \* Quantity of fuses
- \* Packaged date
- \* Country of origin
- \* Manufacturer
- \* Production facilities
- \* Indications required by the applicable standard

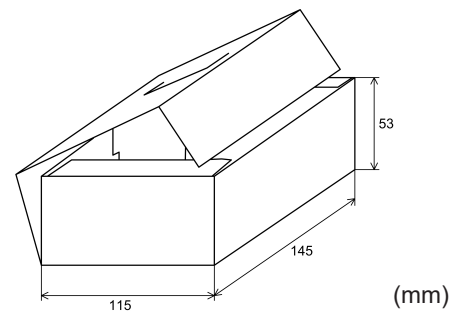
**Lot number:**

The lot number indicates the following:

Example: 17012371      170123: Date manufactured  
71:      Process code



## Ordering specifications:

SOC product name: 250VATSCR [rated current]

## Contact information:

SOC is a global ISO-9001 and IATF16949 registered company headquartered in Japan with subsidiaries in Asia, Europe, and North America.

## SOC Corporation

## Marketing Division:

3-16-17, Takanawa, Minato-ku, Tokyo 108-0074, Japan  
TEL +81-3-5420-1011 FAX +81-3-5420-6699  
<http://www.socfuse.com/contact/index.html>

## SOC America Inc.:

3505 Veterans Memorial Highway, Suite K-1, Ronkonkoma, NY 11779, USA  
TEL +1-631-472-6666 FAX +1-631-472-6777  
<http://www.socamericainc.com>  
[info@socamericainc.com](mailto:info@socamericainc.com)

## SOC Asia Pte. Ltd.:

15 Jalan Kilang Barat, #06-02 Frontech Centre, Singapore 159357  
TEL +65-6376-4115 FAX +65-6376-4117  
<http://www.socfuse.com/contact/index.html>  
[socjp@pacific.net.sg](mailto:socjp@pacific.net.sg)

## SOC Europe B.V.:

Databankweg 1, 3821 AL Amersfoort, the Netherlands  
TEL +31-33-450-4000  
<http://www.soceurope.nl>  
[info@soceurope.nl](mailto:info@soceurope.nl)

**Safety Precautions for Fuse Selection and Use:** **WARNING**

Read and follow these precautions before selecting and using fuses and protectors (hereafter “fuses”). Failure to properly select, install, and use fuses can result in not only property damage, but also serious injury or death.

Use fuses within their specification requirements. Exposing fuses to conditions that exceed or are outside specifications can lead to, for example, non-operation, nuisance operations, disconnection of the fuse-element, or explosions, and may cause injuries and/or property damage. Please note that breaking conditions for currents below the minimum breaking current and which exceed the rated breaking current are outside the range of the specification conditions. Please use this product after ensuring that the actual breaking conditions in the application are not included in this range.

Fuse performance can vary greatly due to the actual conditions fuses are operated under (ambient temperature, pulse currents, heat shock, mechanical stress, etc.). Please consider all conditions a fuse will be exposed to when making a selection. Depending on the conditions, non-operation, nuisance operations, disconnection of the fuse-element, explosions, or other accidents may occur, and these may cause injuries and/or property damage.

The breaking ability of a fuse will differ between AC and DC circuits. Use fuses with AC voltage ratings in AC circuits and fuses with DC voltage ratings in DC circuits. When using fuses with both AC and DC voltage ratings, attention should be given to any differences in breaking ability. A fuse’s breaking ability indicates the fuse’s ability in an AC or DC circuit. For example, if a fuse with an AC voltage rating is used in a DC circuit, the fuse’s breaking ability will decrease, and injuries and/or property damage may occur.

Check if the circuit voltage is large enough for the fuse’s operation. When the circuit voltage is too small, the decrease in current caused by an increase in the fuse’s resistance may prevent the fuse from operating even for abnormal currents.

Do not use fuses in environments with high humidity or corrosive or flammable gases. Doing so may result in nuisance operations, disconnection of the fuse-element, or an explosion.

Do not use ultrasonic waves to clean fuses. Ultrasonic cleaning may cause disconnection of the fuse-element.

Do not form a fuse’s leads when the fuse is at a temperature of 40 °C or greater. Doing so may result in disconnection of the fuse-element because of the applied stress.

Do not apply coating or potting to any fuses except sealed fuses, such as the MCFA, or their equivalents, including the MCF3. Doing so may cause disconnection of the fuse-element or a change in the fuse’s characteristics. Please be aware that even sealed fuses or the equivalent are not hermetically sealed, and therefore make sure to confirm no coating or potting material has penetrated the interior or any other location of the fuse before use. As coating or potting a fuse will change its characteristics, make sure to confirm that a coated or potted fuse still satisfies all requirements under actual usage conditions.

Avoid applying excessive force when inserting a fuse into a fuse holder. Doing so may result in the fuse cracking or in contact failure, and this may significantly reduce its ability to work properly or may shorten its life.

When a fuse is used in equipment that directly affects human life or that requires a high degree of reliability, more closely examine and evaluate the fuse in actual circuit conditions than is necessary for use in other general electronic equipment.

Do not touch fuses when they are carrying a current. Doing so may result in electrocution or serious burns.

Fuses obtained as samples should only be used for evaluation. Do not reuse fuses, but instead properly dispose of them.

For final fuse selection, make sure to install the fuse in the actual application in order to confirm the selected fuse satisfies all requirements.